

REVUE ROUMAINE DE CHIMIE (ROMANIAN JOURNAL OF CHEMISTRY)

Tome 59, N° 8

Août 2014

PAPERS

**Amina BEN BOUABDALLAH
and Nacer-Eddine DJELALI**

Synthesis of polypyrrole's support adsorbed on bentonite. Applications in wastewater treatment

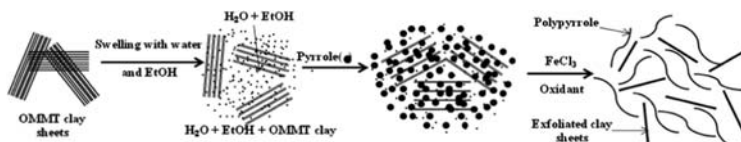

Rev. Roum. Chim., 2014, 59(8), 627-637

Key words: composites, polypyrrole, adsorption, bentonite, wastewater.

**Simona CAPRARESCU, Violeta PURCAR,
Andrei SÂRBU, Anita-Laura RADU,
Marius GHIUREA and Ioana MAIOR**

The use of electro dialysis for Cu^{2+} removal from wastewater

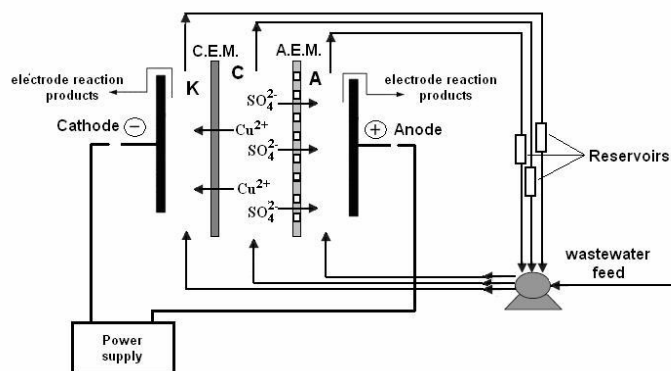

Rev. Roum. Chim., 2014, 59(8), 639-644

Key words: electro dialysis, copper ions, wastewater, environmental protection, flow rate.

**Cassiana Cristina ANDREI, Laura SÂRDAN,
Sorana IONESCU, Daniela BALA
and Constantin MIHAILCIUC**

Comparative electrochemical study of 2,2-diphenyl-1-(2,6-dinitro-4-trifluoromethylphenyl)hydrazine and 2,2-di-*p*-tolyl-1-(2,4,6-trinitrophenyl)hydrazine

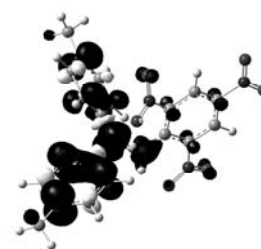
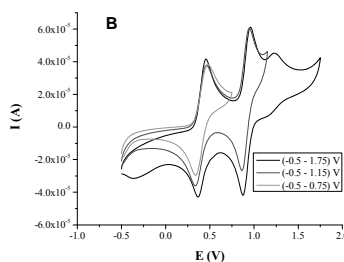

Rev. Roum. Chim., 2014, 59(8), 645-655

Key words: CV, DPV, hydrazine derivatives.

**Adriana MARINOIU, Claudia COBZARU,
Elena CARCADEA,
Mircea RACEANU, Irina PETREANU
and Mihai VARLAM**

Study about glycerol hydrogenolysis using copper chromite catalysts mixed with bases

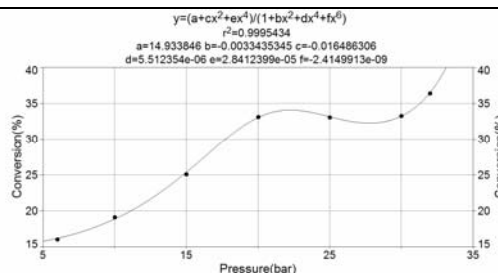

Rev. Roum. Chim., 2014, 59(8), 657-662

Key words: mathematical modeling, hydrogenolysis, propylene glycol, copper chromite catalysts.

Otilia Ana CULICOV, Inga ZINICOVSCAIA,
Tanta SETNESCU, Radu SETNESCU
and Marina Vladimirovna FRONTASYEVA

Elemental content of edible oils studied by neutron
activation analysis

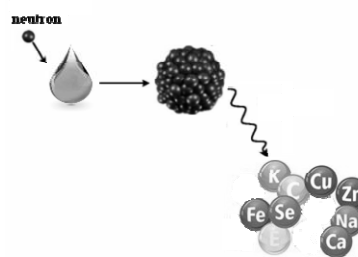

Key words: elemental content, heavy metals, neutron activation analysis,
olive oil, sunflower oil.

Rev. Roum. Chim., 2014, 59(8), 663-667

Anca Ruxandra LEONTIES,
Adina RADUCAN, Mihaela PUIU
and Dumitru OANCEA

Extension of isoconversional approach to enzyme
inactivation for some uncommon systems

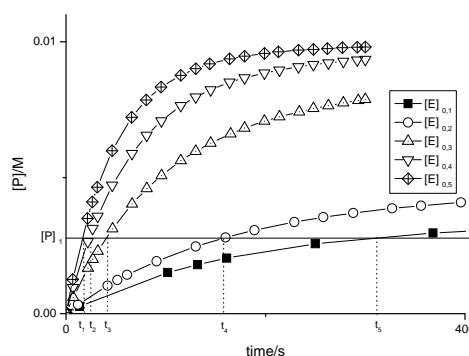

Key words: enzyme inactivation, phenol oxidation, isoconversional method.

Rev. Roum. Chim., 2014, 59(8), 669-674

Fulga TANASĂ, Mădălina ZĂNOAGĂ
and Marioara NECHIFOR

Effect of an organically modified nanoclay
on the properties of some compatibilized
PP-wood composites

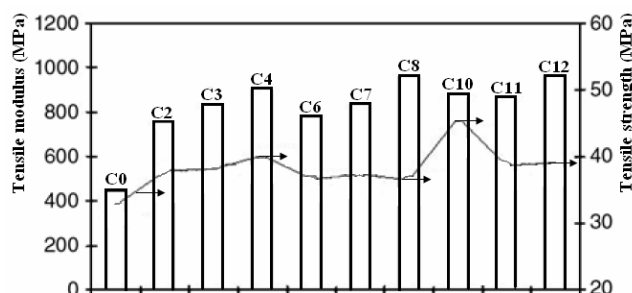

Key words: polymer-clay-wood nanocomposites, properties,
exfoliation/intercalation.

Rev. Roum. Chim., 2014, 59(8), 675-682

Mariana DUCA, Iulia MATEI
and Mihaela HILLEBRAND

Photophysical properties of two derivatives
in the phenoxathiin-10,10-dioxide class

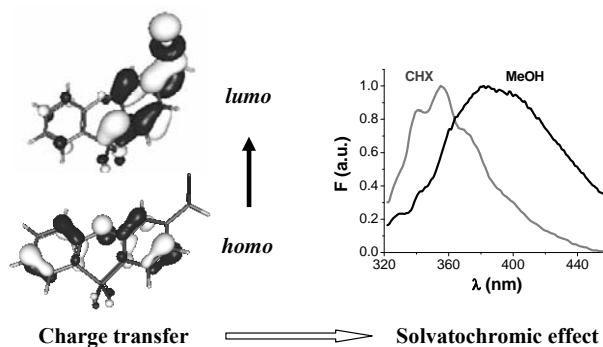

Key words: phenoxathiin-sulphone derivatives, solvatochromic effects in the
emission spectrum, Kamlet-Taft analysis, TDDFT calculations.

Rev. Roum. Chim., 2014, 59(8), 683-691

**Violet KASABRI, Fatma U. AFIFI,
Rana ABU-DAHAB, Nizar MHAI DAT,
Yasser K. BUSTANJI, Ismail M. ABAZA
and Sundus MASHALLAH**

In vitro modulation of metabolic syndrome enzymes and proliferation of obesity related-colorectal cancer cell line panel by *Salvia* species from Jordan

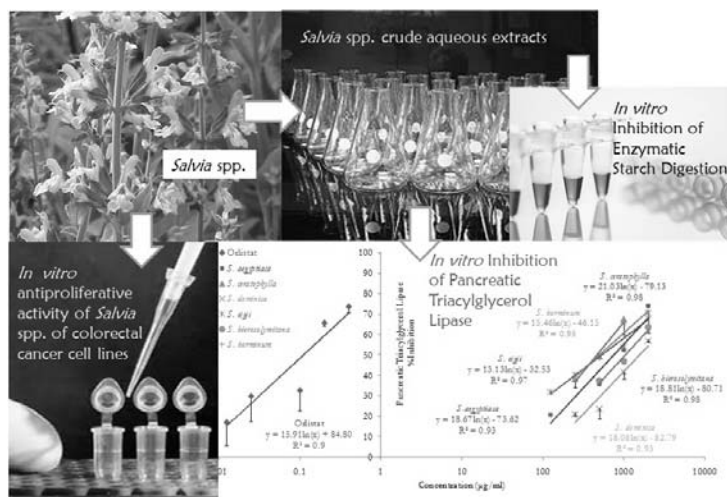

Key words: *Salvia* species (Lamiaceae), pancreatic lipase, α -amylase and α -glucosidase, colorectal cancer, Jordan.

Rev. Roum. Chim., 2014, 59(8), 693-705

NOTE

**Maria Victoria NEACSU, Florentina ISRAEL
ROMING, Aleksandar BIJELIC
and Gabriela IONITA**

The ozone effects on the chloroplasts extracted from *Rumex patienta* – an EPR investigation

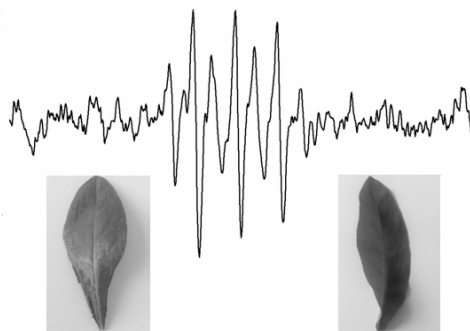

Rev. Roum. Chim., 2014, 59(8), 707-713

Key words: EPR spectroscopy, ozone, oxidative stress, chloroplasts.

